

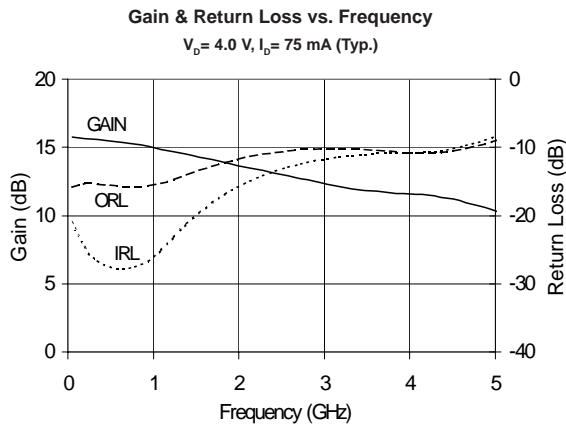

Product Description

The SGA-6389 is a high performance SiGe HBT MMIC Amplifier. A Darlington configuration featuring 1 micron emitters provides high F_T and excellent thermal performance. The heterojunction increases breakdown voltage and minimizes leakage current between junctions. Cancellation of emitter junction non-linearities results in higher suppression of intermodulation products. Only 2 DC-blocking capacitors, a bias resistor and an optional RF choke are required for operation.

The matte tin finish on Sirenza's lead-free package utilizes a post annealing process to mitigate tin whisker formation and is RoHS compliant per EU Directive 2002/95. This package is also manufactured with green molding compounds that contain



SGA-6389

SGA-6389Z RoHS Compliant & Green Package

DC-4500 MHz, Cascadable SiGe HBT MMIC Amplifier



Product Features

- Now available in Lead Free, RoHS Compliant, & Green Packaging
- Broadband Operation: DC-4500 MHz
- Cascadable 50ohm
- Patented SiGe Technology
- Operates From Single Supply
- Low Thermal Resistance Package

Applications

- PA Driver Amplifier
- Cellular, PCS, GSM, UMTS
- IF Amplifier
- Wireless Data, Satellite

Symbol	Parameter	Units	Frequency	Min.	Typ.	Max.
G	Small Signal Gain	dB	850 MHz 1950 MHz 2400 MHz	14.1	15.5 14.0 13.3	17.3
P_{1dB}	Output Power at 1dB Compression	dBm	850 MHz 1950 MHz		20.2 18.9	
OIP_3	Output Third Order Intercept Point	dBm	850 MHz 1950 MHz		35.2 32.6	
Bandwidth	Determined by Return Loss (>10dB)	MHz			4500	
IRL	Input Return Loss	dB	1950 MHz		16.0	
ORL	Output Return Loss	dB	1950 MHz		11.9	
NF	Noise Figure	dB	1950 MHz		4.2	
V_D	Device Operating Voltage	V		4.6	4.9	5.4
I_D	Device Operating Current	mA		72	80	88
R_{TH} , j-l	Thermal Resistance (junction to lead)	$^{\circ}\text{C}/\text{W}$			97	
Test Conditions: $V_S = 8\text{v}$ $I_D = 80\text{mA Typ.}$ $OIP3$ Tone Spacing = 1 MHz, P_{out} per tone = 0 dBm $R_{BIAS} = 39\text{ ohms}$ $T_L = 25^{\circ}\text{C}$ $Z_S = Z_L = 50\text{ Ohms}$						

The information provided herein is believed to be reliable at press time. Sirenza Microdevices assumes no responsibility for inaccuracies or omissions. Sirenza Microdevices assumes no responsibility for the use of this information, and all such information shall be entirely at the user's own risk. Prices and specifications are subject to change without notice. No patent rights or licenses to any of the circuits described herein are implied or granted to any third party. Sirenza

Typical RF Performance at Key Operating Frequencies

Symbol	Parameter	Unit	Frequency (MHz)					
			100	500	850	1950	2400	3500
G	Small Signal Gain	dB	15.7	15.6	15.5	14.0	13.3	12.0.
OIP ₃	Output Third Order Intercept Point	dBm	36.6	36.0	35.2	32.6	31.2	26.8
P _{1dB}	Output Power at 1dB Compression	dBm	20.1	20.4	20.2	18.9	18.1	15.5
IRL	Input Return Loss	dB	22.3	27.5	27.4	16.0	13.7	11.0
ORL	Output Return Loss	dB	14.7	14.5	14.8	11.9	10.8	10.4
S ₁₂	Reverse Isolation	dB	20.4	20.2	20.3	20.1	19.7	18.2
NF	Noise Figure	dB	4.0	3.7	3.8	4.2	4.4	4.8

Test Conditions: V_S = 8v, I_D = 80mA Typ., OIP3 Tone Spacing = 1 MHz, Pout per tone = 0 dBm
R_{BIAS} = 39 ohms, T_L = 25°C, Z_S = Z_L = 50 Ohms

Noise Figure vs. Frequency
V_D = 4.9 V, I_D = 80 mA

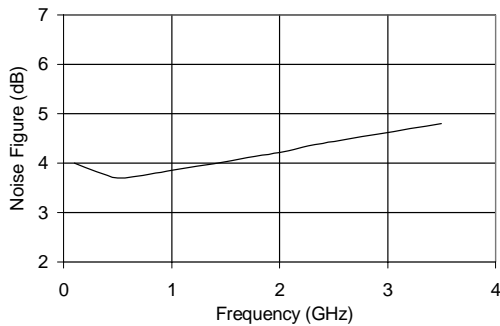

Absolute Maximum Ratings

Parameter	Absolute Limit
Max. Device Current (I _D)	160 mA
Max. Device Voltage (V _D)	7 V
Max. RF Input Power	+18 dBm
Max. Junction Temp. (T _J)	+150°C
Operating Temp. Range (T _L)	-40°C to +85°C
Max. Storage Temp.	+150°C

Operation of this device beyond any one of these limits may cause permanent damage. For reliable continuous operation, the device voltage and current must not exceed the maximum operating values specified in the table on page one.

Bias Conditions should also satisfy the following expression:
 $I_D V_D < (T_J - T_L) / R_{TH} \cdot I$

Take into account out of band VSWR presented by devices such as SAW filters to determine maximum RF input power. Reflected harmonic levels in saturation are significant.

OIP₃ vs. Frequency
V_D = 4.9 V, I_D = 80 mA

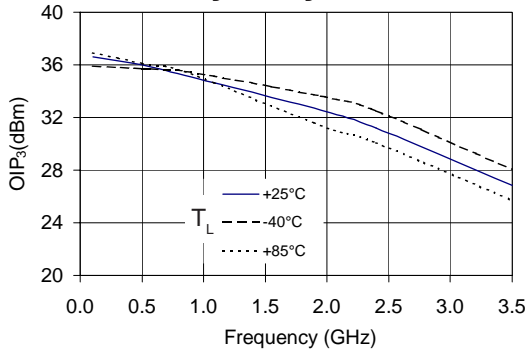

P_{1dB} vs. Frequency
V_D = 4.9 v, I_D = 80 mA

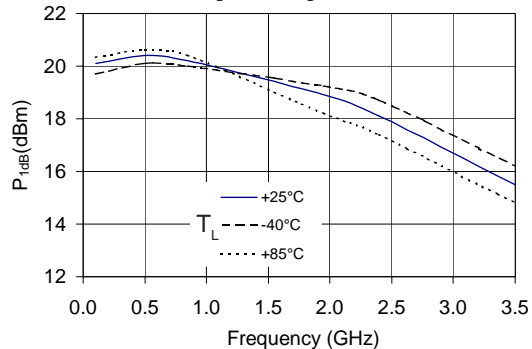

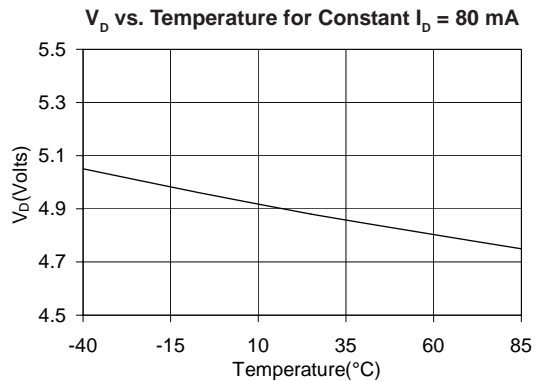
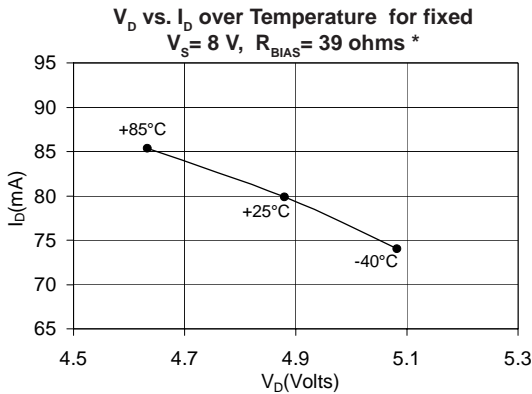
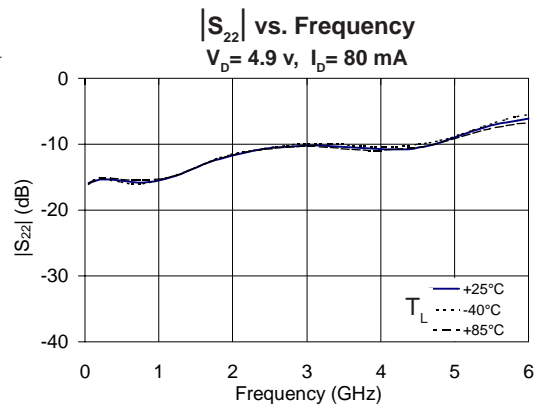
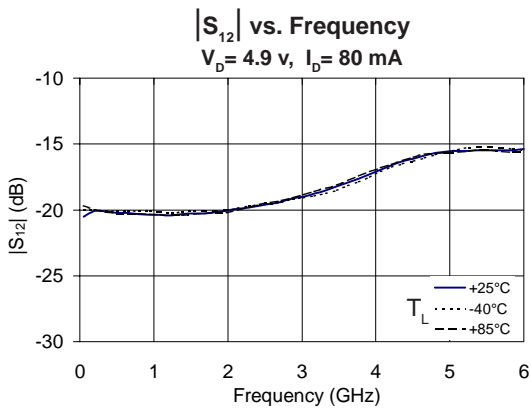
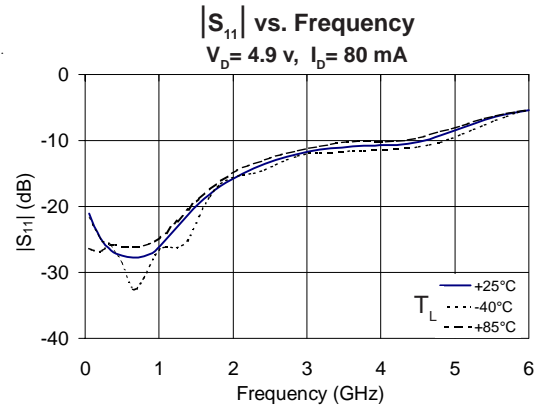
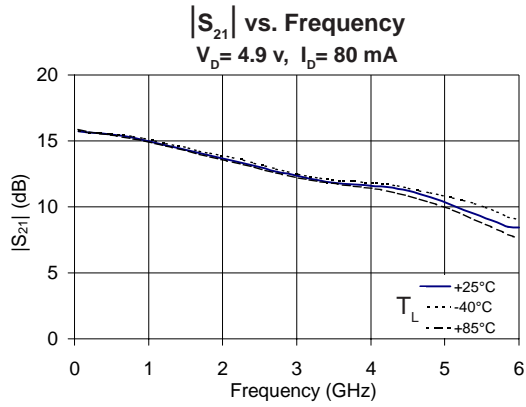

* Note: In the applications circuit on page 4, R_{BIAS} compensates for voltage and current variation over temperature.

Basic Application Circuit

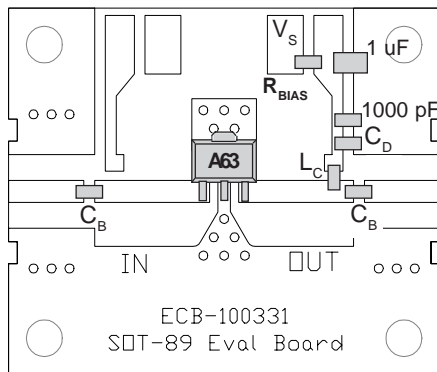
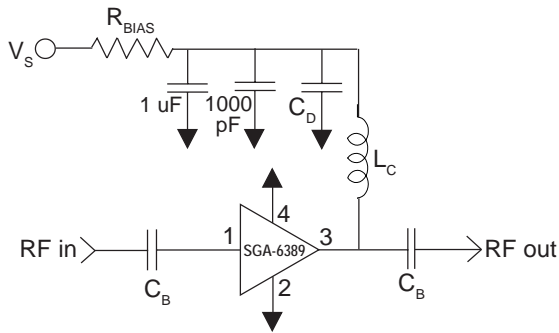

Part Identification Marking

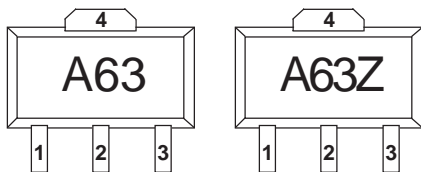

Caution: ESD sensitive
Appropriate precautions in handling, packaging and testing devices must be observed.

**See Application Note AN-075
for Package Outline Drawing**

Application Circuit Element

Reference Designator	Frequency (Mhz)				
	500	850	1950	2400	3500
C _B	220 pF	100 pF	68 pF	56 pF	39 pF
C _D	100 pF	68 pF	22 pF	22 pF	15 pF
L _C	68 nH	33 nH	22 nH	18 nH	15 nH

Recommended Bias Resistor Values for I_b=80mA

$$R_{BIAS} = (V_S - V_D) / I_b$$

Supply Voltage(V _S)	6 V	8 V	10 V	12 V
R _{BIAS}	13 Ω	39 Ω	62 Ω	91 Ω

Note: R_{BIAS} provides DC bias stability over temperature.

Mounting Instructions

1. Solder the copper pad on the backside of the device package to the ground plane.
2. Use a large ground pad area with many plated through-holes as shown.
3. We recommend 1 or 2 ounce copper. Measurements for this data sheet were made on a 31 mil thick FR-4 board with 1 ounce copper on both sides.

Pin #	Function	Description
1	RF IN	RF input pin. This pin requires the use of an external DC blocking capacitor chosen for the frequency of operation.
2, 4	GND	Connection to ground. For optimum RF performance, use via holes as close to ground leads as possible to reduce lead inductance.
3	RF OUT/ BIAS	RF output and bias pin. DC voltage is present on this pin, therefore a DC blocking capacitor is necessary for proper operation.

Part Number Ordering Information

Part Number	Reel Size	Devices/Reel
SGA-6389	13"	3000
SGA-6389Z	13"	3000